

# Snappy 300 Instruction Manual



---

This assembly instruction is designed to provide a step by step guide to ensure easy and safe erection using the 3T (Through The Trap) build method.

Read this guide and ensure understanding before starting assembly.

The guide shows construction of a spigot-down system. A spigot-up system follows the same steps.

## SAFE WORKING LOADS AND WORKING HEIGHTS The

The Snappy 300 has been designed for Class 3 load conditions.

The total load on the tower should not exceed 360kg.

Do not extend the build height above that shown in this guide.

### ASSEMBLY PROCESS

#### 1. Preparation

- Locate the tower, ensuring ground is level.
- Unlock the interlock clips on all frames.
- When installed, always move the interlock clip to the "locked" position.
- Sort the braces into horizontal and diagonal braces - the diagonals are slightly longer.
- Unlock the brace locks.



#### 2. Base

- Ensure the base is level.
- Lock castors before ascending any part of the tower.

Note the locking and unlocking position for the castors as shown here.

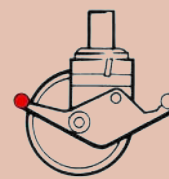

#### 3. Locking down the platform (Windlock)

A windlock clip is installed on the platform at the hook. This is locked as shown.



## USAGE ADVICE

- We recommend a minimum of two people to assemble, dismantle and move the platform tower.
- Check that all components are on site and in good working order.
- Ensure that the assembly location is checked to prevent hazards during assembly, dismantling or moving and while working on the tower. Particular attention should be given to the ground condition, whether level or sloping, obstructions and wind conditions. The ground condition must be capable of supporting the tower structure.
- Towers must always be climbed from the inside of the assembly using the ladder.
- Lifting of components must be done inside the effective base area of the tower; components are normally hoisted using a rope.
- Moving the tower must only be done by manual effect from the base of the tower.
- When moving tower be aware of overhead hazards (e.g. electric cables).
- No personnel or material to be on the platform whilst the tower is being moved.
- Beware of horizontal loads which can lead to instability of the tower. The maximum side force is 20kg.
- Do not use boxes or steps to gain additional height. If extra height required, contact your distributor to get extra components.
- Do not lift or suspend an assembled mobile tower.
- Damaged components or components from other tower systems must never be used.
- Stabilisers should always be fitted when specified. Use the stabiliser shown on the component list according to the tower height.
- When wind exceeds Beaufort force 4, cease using the tower.
- If wind is expected to reach Beaufort force 6, tie tower to a rigid structure.
- If winds of Force 8 are forecast, dismantle the tower or remove to shelter.
- Ensure that the guardrail protection meets all national safety regulations.

Wind speeds				
Force	Peak mph	Peak km/h	Peak m/s	Guidance
4	18	29	8.1	Moderate breeze - raises dust & loose paper
6	31	50	13.9	Strong breeze - difficult to use umbrella
8	48	74	20.8	Gale force - walking is difficult

## CARE AND MAINTENANCE

- Keep all equipment clean, especially spigots and sockets where frames join. Spigots should fit easily into sockets. Lubricate with light oil.
- Remove dirt or paint from adjustable legs with a light brush, lightly oil the leg locks.
- Do not strike or hammer components. Do not throw or drop onto hard surfaces.
- Lightly oil spring mechanism of the hooks.
- For transport and storage, components are best stored vertically.
- Damaged parts must be repaired or replaced; refer to the Instant Upright website for further advice or contact your equipment supplier for advice.

## STABILISERS

Outriggers are to be used, when specified, to guarantee the structural stability of the tower.

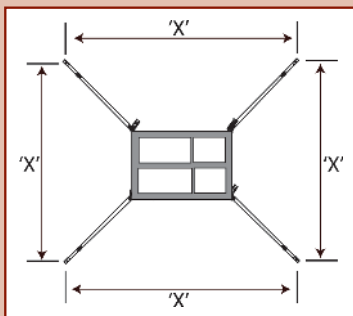

Fig 2



Fig 3

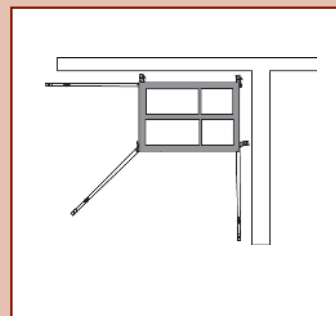

Fig 4

### ALWAYS ENSURE STABILISER SIZE IS CORRECT AND ABLE TO SUPPORT TOWER

Lightly tighten the upper clamps above the sixth rung on each corner post. Position the lower clamp above the bottom rung. Ensure the lower arm is as horizontal as possible. Position the stabilisers so that the footpads are approximately equidistant from each other, as shown in Fig.2. Adjust the outrigger and reposition the clamps as required to make firm contact with the ground. Ensure the clips with locking pin are in place. When in the correct position, tighten the clamps firmly.

To position the tower against a wall, do not remove the stabiliser; move parallel with the wall. (Fig.3)

To position the tower in a corner, remove the inside stabiliser and place the outside two parallel with the wall. (Fig.4)

## SPECIFIC PRODUCT INFORMATION

Table of parts and quantities

Snappy 300 - 1.2m, 2m, 3m and 4m to BS1139-6 to EN1004 and WAHR				
Platform Height (m)	1.2m	2m	3m	4m
Work Height (m)	3.2m	4m	5m	6m
Tower Height (m)	2m	3m	4m	5m
Tower Weight in kg	45.6	67.1	108.8	124.6

Description	Weight (kg)	1.2m	2m	3m	4m
Snappy base frame	22.3	1	1	1	1
Horizontal brace (2m)	1.7		1	1	5
Diagonal brace (2m)	1.8				2
Trapdoor platform (2m)	14.1	1	1	2	2
Guardrail frame	2.7		2		2
Guardrail bracing-frame (2m)	3.8		2	2	2
Extension frame	8.5			2	2
Stabiliser	4			4	4
Castor	2.3	4	4	4	4
Toe-board set (2m)	6.8		1	1	1

## MOVING TOWER

To move the tower to a new position, first prepare the tower.

- Check that the wind speed does not exceed 29km/h (8.1m/s).
- Ensure the tower is empty (material and personnel)
- Check for overhead obstructions including electrical cables.
- Raise and stabiliser feet (only enough to clear obstructions).
- Taking care to ensure tower stability is maintained.
- Release the castor brakes.
- Carefully move the tower by manually applying force at the base. Do not use mechanical means to move the tower.
- Once positioned prepare the tower for use.
- Check and adjust as necessary to ensure all castors and stabilisers are in firm contact with the ground.
- Check that the tower is vertical using a spirit level.
- Reapply the castor brakes.

**SNAPPY 300 – 1.2m**

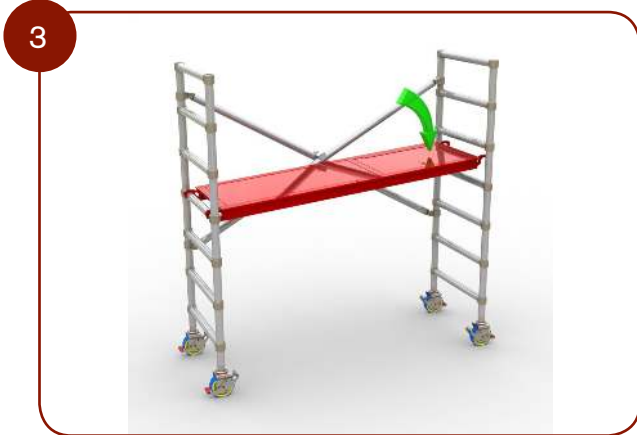
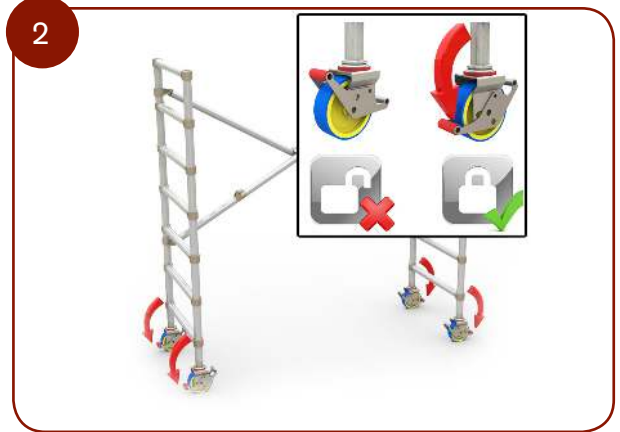
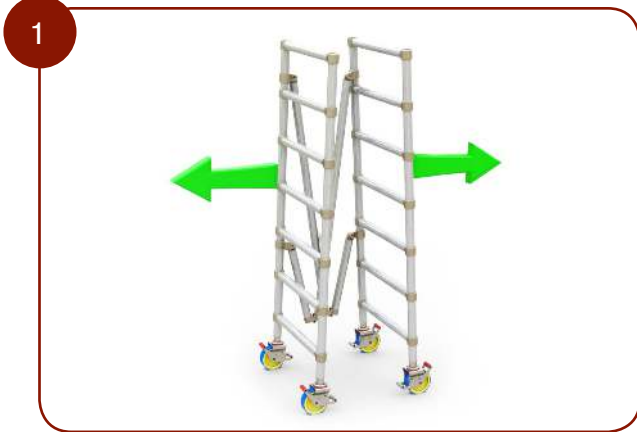

**SNAPPY 300 – 2m**

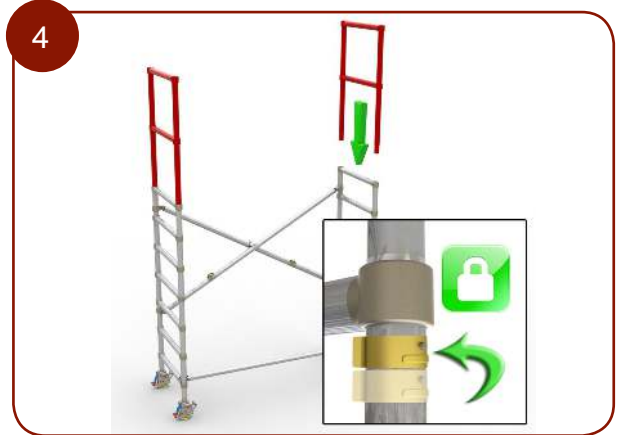
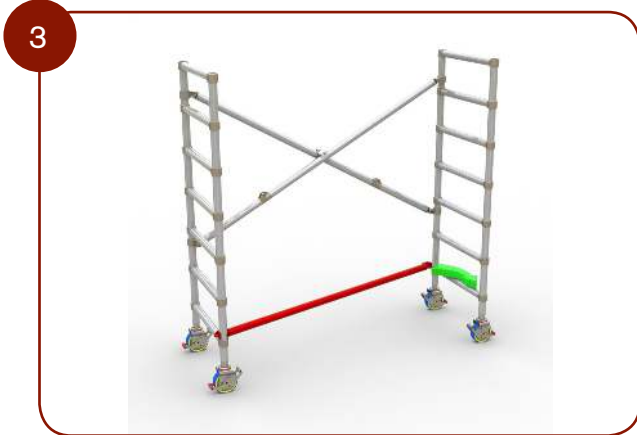
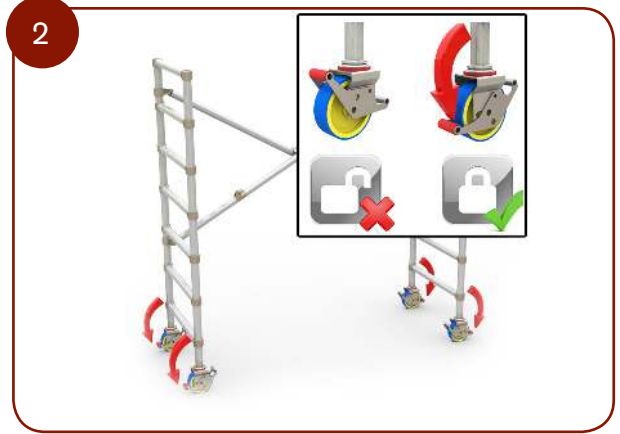
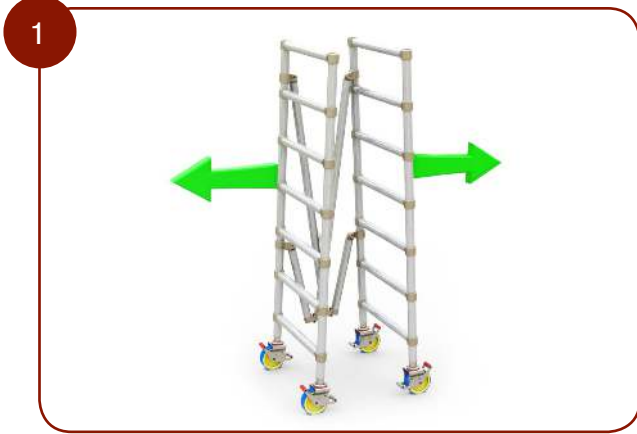

**SNAPPY 300 – 3m**

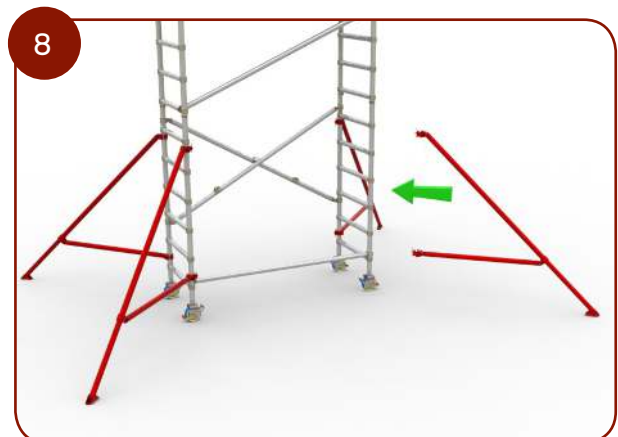
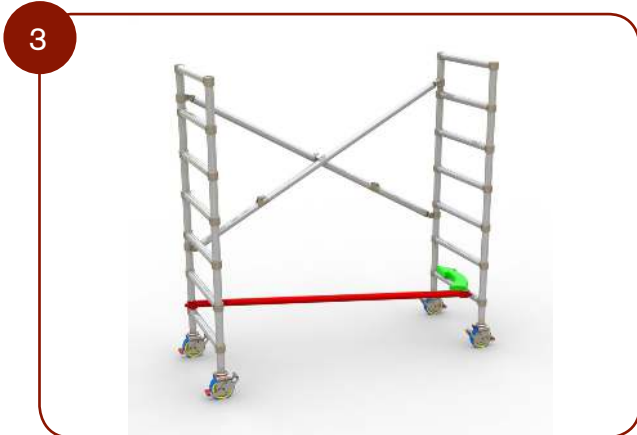
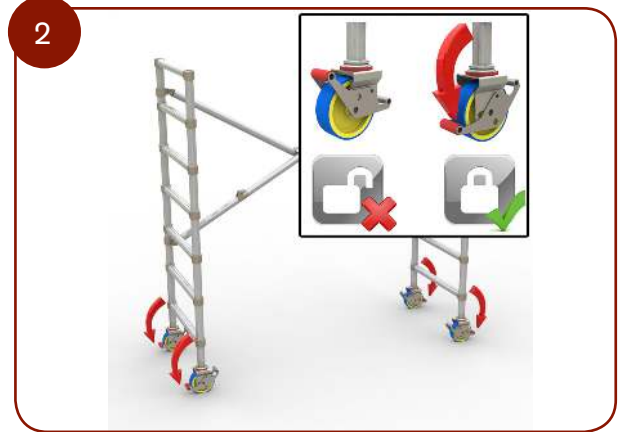
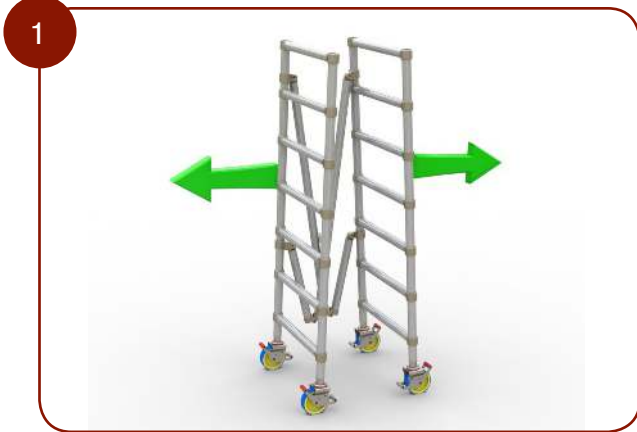



### SNAPPY 300 – 3m Continued



**SNAPPY 300 - 4m**

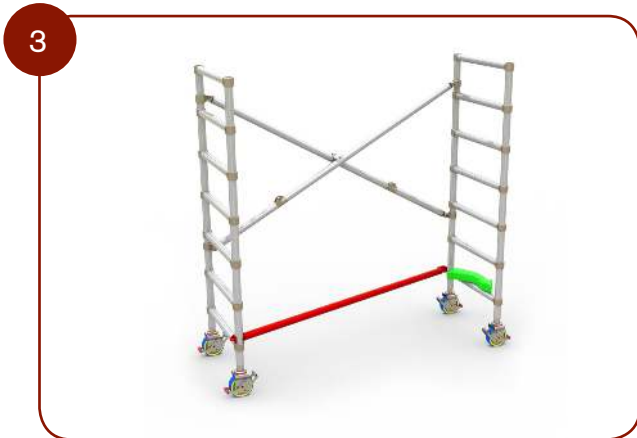
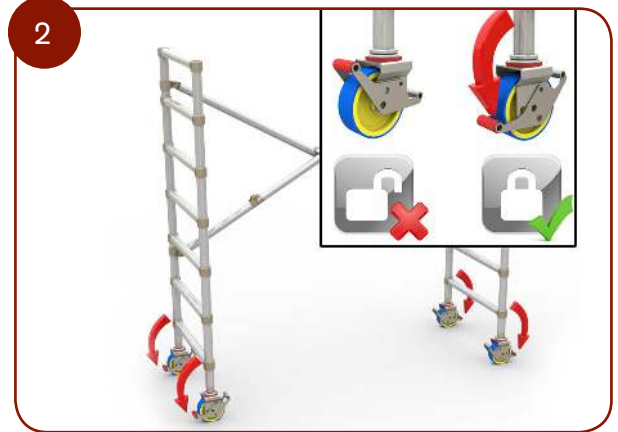

### SNAPPY 300 – 4m Continued

